

TABLE OF CONTENTS

CHAPTER 1	BASIC CONCEPTS OF SQL	Page no
1.1	Introduction to SQL	3
1.2	SQL(Structured Query Language)	14-15
1.3	How to start <i>isqlplus</i>	16
1.4	Select Statement	17-25
1.5	Data Definition Language	26-35
1.6	Data Manipulation Language	36-38
1.7	TCL -Transaction Control Language	39
1.8	Multi Table Queries	40-43
1.9	Views and SubQueries	44-48
1.10	Standard Functions	49-57
1.11	Group Functions	58-61
CHAPTER 2	LAB PROGRAM 1 - STUDENT FACULTY DATABASE	
2.1	Problem Statement	62
2.2	Schema and Design	63-64
2.3	Creating Tables	65-66
2.4	Inserting Values	67
2.5	Schema Description	68-69
2.6	Queries and Solutions	70-71
CHAPTER 3	LAB PROGRAM 2 - AIRLINE FLIGHT DATABASE	
3.1	Problem Statement	72
3.2	Schema and Design	73-74
3.3	Creating Tables	75
3.4	Inserting Values	76
3.5	Schema Description	77-78
3.6	Queries and Solutions	79-80
CHAPTER 4	LAB PROGRAM 3 - STUDENT ENROLLMENT DATABASE	

4.1	Problem Statement	81
4.2	Schema and Design	82-83
4.3	Creating Tables	84-85
4.4	Inserting Values	86
4.5	Schema Description	87-88
4.6	Queries and Solutions	89-90
CHAPTER 5	LAB PROGRAM 4 - BOOK DEALER DATABASE	
5.1	Problem Statement	91
5.2	Schema and Design	92-93
5.3	Creating Tables	94-95
5.4	Inserting Values	96
5.5	Schema Description	97-98
5.6	Queries and Solutions	99-100
CHAPTER 6	LAB PROGRAM 5 - BANKING ENTERPRISE DATABASE	
6.1	Problem Statement	101
6.2	Schema and Design	102-103
6.3	Creating Tables	104-105
6.4	Inserting Values	106
6.5	Schema Description	107-108
6.6	Queries and Solutions	109-110
CHAPTER 7	REPORT GENERATION PROCEDURE	
7.1	Steps to generate reports and Example Report	111-117
7.2	Exercises	
	APPENDIX I	118-120
	APPENDIX II	121-123
	APPENDIX III	124-132
	APPENDIX IV	133-135
	BIBLIOGRAPHY	136

CHAPTER – 1

BASIC CONCEPTS OF SQL

1.1 Introduction to SQL

SQL stands for “Structured Query Language” and can be pronounced as “SQL” or “sequel – (Structured English Query Language)”. It is a query language used for accessing and modifying information in the database. IBM first developed SQL in 1970s. Also it is an ANSI/ISO standard. It has become a Standard Universal Language used by most of the relational database management systems (RDBMS). Some of the RDBMS systems are: Oracle, Microsoft SQL server, Sybase etc. Most of these have provided their own implementation thus enhancing its feature and making it a powerful tool. Few of the SQL commands used in SQL programming are SELECT Statement, UPDATE Statement, INSERT INTO Statement, DELETE Statement, WHERE Clause, ORDER BY Clause, GROUP BY Clause, ORDER Clause, Joins, Views, GROUP Functions, Indexes etc.

1.2 SQL Commands

SQL commands are instructions used to communicate with the database to perform specific task that work with data. SQL commands can be used not only for searching the database but also to perform various other functions like, for example, you can create tables, add data to tables, or modify data, drop the table, set permissions for users. SQL commands are grouped into four major categories depending on their functionality:

- **Data Definition Language (DDL)** - These SQL commands are used for creating, modifying, and dropping the structure of database objects. The commands are CREATE, ALTER, DROP, RENAME, and TRUNCATE.
- **Data Manipulation Language (DML)** - These SQL commands are used for storing, retrieving, modifying and deleting data. These commands are SELECT, INSERT, UPDATE, and DELETE.
- **Transaction Control Language (TCL)** - These SQL commands are used for managing changes affecting the data. These commands are COMMIT, ROLLBACK, and SAVEPOINT.

- **Data Control Language (DCL)** - These SQL commands are used for providing security to database objects. These commands are GRANT and REVOKE.

1.2.1 Data Definition Language (DDL)

1.2.1.1 CREATE TABLE Statement

The CREATE TABLE Statement is used to create tables to store data. Integrity Constraints like primary key, unique key and foreign key can be defined for the columns while creating the table. The integrity constraints can be defined at column level or table level. The implementation and the syntax of the CREATE Statements differs for different RDBMS.

The Syntax for the CREATE TABLE Statement is:

```
CREATE TABLE table_name
(column_name1 datatype constraint,
column_name2 datatype, ...
column_nameN datatype);
```

- **table_name** - is the name of the table.
- **column_name1, column_name2....** - is the name of the columns
- **datatype** - is the datatype for the column like char, date, number etc.

SQL Data Types:

char (size)	Fixed-length character string. Size is specified in parenthesis. Max 255 bytes.
Varchar2 (size)	Variable-length character string. Max size is specified in parenthesis.
number (size) or int	Number value with a max number of column digits specified in parenthesis.
Date	Date value in 'dd-mon-yy'. Eg., '07-jul-2004'
number (size, d) or real	Number value with a maximum number of digits of "size" total, with a maximum number of "d" digits to the right of the decimal.

SQL Integrity Constraints:

Integrity Constraints are used to apply business rules for the database tables. The constraints available in SQL are **Foreign Key, Primary key, Not Null, Unique, Check**.

Constraints can be defined in two ways:

1. The constraints can be specified immediately after the column definition. This is called column-level definition.
2. The constraints can be specified after all the columns are defined. This is called table-level definition.

1) Primary key:

This constraint defines a column or combination of columns which uniquely identifies each row in the table.

Syntax to define a Primary key at column level:

```
Column_name datatype [CONSTRAINT constraint_name] PRIMARY KEY
```

Syntax to define a Primary key at table level:

```
[CONSTRAINT constraint_name] PRIMARY KEY(column_name1, column_name2,..)
```

- **column_name1, column_name2** are the names of the columns which define the primary key.
- The syntax within the bracket i.e. [CONSTRAINT constraint_name] is optional.

2) Foreign key or Referential Integrity:

This constraint identifies any column referencing the PRIMARY KEY in another table. It establishes a relationship between two columns in the same table or between different tables. For a column to be defined as a Foreign Key, it should be defined as a Primary Key in the table which it is referring. One or more columns can be defined as Foreign key.

Syntax to define a Foreign key at column level:

```
[CONSTRAINT constraint_name] REFERENCES referenced_table_name(column_name)
```

Syntax to define a Foreign key at table level:

```
[CONSTRAINT constraint_name] FOREIGN KEY(column_name) REFERENCES  
referenced_table_name(column_name);
```

3) Not Null Constraint:

This constraint ensures all rows in the table contain a definite value for the column which is specified as not null. Which means a null value is not allowed.

Syntax to define a Not Null constraint:

```
[CONSTRAINT constraint_name] NOT NULL
```

4) Unique Key:

This constraint ensures that a column or a group of columns in each row have a distinct value. A column(s) can have a null value but the values cannot be duplicated.

Syntax to define a Unique key at column level:

```
[CONSTRAINT constraint_name] UNIQUE
```

Syntax to define a Unique key at table level:

```
[CONSTRAINT constraint_name] UNIQUE(column_name)
```

5) Check Constraint:

This constraint defines a business rule on a column. All the rows must satisfy this rule. The constraint can be applied for a single column or a group of columns.

Syntax to define a Check constraint:

```
[CONSTRAINT constraint_name] CHECK (condition)
```

1.2.1.2 ALTER TABLE Statement

The SQL ALTER TABLE command is used to modify the definition structure) of a table by modifying the definition of its columns. The ALTER command is used to perform the following functions.

- 1) Add, drop, modify table columns
- 2) Add and drop constraints
- 3) Enable and Disable constraints

Syntax to add a column

```
ALTER TABLE table_name ADD column_name datatype;
```

For Example: To add a column "experience" to the employee table, the query would be like

```
ALTER TABLE employee ADD experience number(3);
```

Syntax to drop a column

```
ALTER TABLE table_name DROP column_name;
```

For Example: To drop the column "location" from the employee table, the query would be like

```
ALTER TABLE employee DROP location;
```

Syntax to modify a column

```
ALTER TABLE table_name MODIFY column_name datatype;
```

For Example: To modify the column salary in the employee table, the query would be like

```
ALTER TABLE employee MODIFY salary number(15,2);
```

Syntax to add PRIMARY KEY constraint

```
ALTER TABLE table_name ADD CONSTRAINT constraint_name PRIMARY KEY column_name;
```

Syntax to drop PRIMARY KEY constraint

```
ALTER TABLE table_name DROP PRIMARY KEY;
```

1.2.1.3 The DROP TABLE Statement

The DROP TABLE statement is used to delete a table.

```
DROP TABLE table_name;
```

1.2.1.4 TRUNCATE TABLE Statement

What if we only want to delete the data inside the table, and not the table itself?

Then, use the TRUNCATE TABLE statement:

```
TRUNCATE TABLE table_name;
```

1.2.2 Data Manipulation Language (DML):

The SELECT Statement

The SELECT statement is used to select data from a database. The result is stored in a result table, called the result-set.

SELECT Syntax:

```
SELECT * FROM table_name;
```

The SELECT DISTINCT Statement

In a table, some of the columns may contain duplicate values. This is not a problem, however, sometimes you will want to list only the different (distinct) values in a table. The DISTINCT keyword can be used to return only distinct (different) values.

SELECT DISTINCT Syntax:

```
SELECT DISTINCT column_name(s)
FROM table_name;
```

The WHERE Clause

The WHERE clause is used to extract only those records that fulfill a specified criterion.

WHERE Syntax:

```
SELECT column_name(s)
FROM table_name
WHERE column_name operator value;
```

The AND & OR Operators

- The AND operator displays a record if both the first condition and the second condition is true.
- The OR operator displays a record if either the first condition or the second condition is true.

The ORDER BY Clause

- The ORDER BY clause is used to sort the result-set by a specified column.

- The ORDER BY clause sort the records in ascending order by default.
- If you want to sort the records in a descending order, you can use the DESC keyword.

ORDER BY Syntax:

```
SELECT column_name(s)
FROM table_name
ORDER BY column_name(s) ASC|DESC;
```

The GROUP BY Clause

The GROUP BY clause can be used to create groups of rows in a table. Group functions can be applied on such groups.

GROUP BY Syntax;

```
SELECT column_name(s)
FROM table_name
WHERE column_name operator value
GROUP BY column_name(s);
```

Group functions	Meaning
AVG([DISTINCT ALL],N)	Returns average value of n
COUNT(* [DISTINCT ALL]expr)	Returns the number of rows in the query. When you specify expr, this function considers rows where expr is not null. When you specify the asterisk (*), this function Returns all rows, including duplicates and nulls. You can count either all rows, or only distinct values of expr.
MAX([DISTINCT ALL]expr)	Returns maximum value of expr
MIN([DISTINCT ALL]expr)	Returns minimum value of expr
SUM([DISTINCT ALL]n)	Returns sum of values of n

The HAVING clause

The HAVING clause can be used to restrict the display of grouped rows. The result of the grouped query is passed on to the HAVING clause for output filtration.

HAVING Syntax;

```
SELECT column_name(s)
FROM table_name
WHERE column_name operator value
GROUP BY column_name(s)
HAVING condition;
```

The INSERT INTO Statement

The INSERT INTO statement is used to insert a new row in a table.

SQL INSERT INTO Syntax:

It is possible to write the INSERT INTO statement in two forms.

- The first form doesn't specify the column names where the data will be inserted, only their values:

```
INSERT INTO table_name VALUES (value1, value2, value3,...);
```

OR

```
INSERT INTO table_name VALUES(&column1, &column2, &column3,...);
```

- The second form specifies both the column names and the values to be inserted:

```
INSERT INTO table_name (column1, column2, column3,...)
```

```
VALUES (value1, value2, value3,...);
```

The UPDATE Statement

The UPDATE statement is used to update existing records in a table.

SQL UPDATE Syntax:

```
UPDATE table_name
```

```
SET column1=value, column2=value2,...
```

```
WHERE some_column=some_value;
```

The DELETE Statement

The DELETE statement is used to delete rows in a table.

SQL DELETE Syntax:

```
DELETE FROM table_name
```

```
WHERE some_column=some_value;
```

DESIGNING A REPORT IN ORACLE

Clearing prior settings:

All settings need to be cleared before beginning to set up a report.

- CLEAR SCREEN

The above statements will clear the settings only; there is no interaction with base table description or content data.

Skip n : At the end of each statement the number of lines to be skipped can be specified. The default is no lines skipped.

Title:

TTITLE:

- A multi-line top title can be assigned. This title will repeat at the top of each page.
- Each character string can be aligned, LEFT, RIGHT or CENTER.
- SKIP will advance to the next line, while SKIP n will advance n lines.
- System maintained values can be included:
 - SQL.PNO (current page number)
 - SQL.USER (current username)
- TTITLE OFF suppresses display of the title.
- TTITLE with no clauses reinstates the title previously defined.

BTITLE:

- Sets the bottom title using statements similar to those for TTITLE.

• Example:

```
SQL>TTITLE 'BOOK DEALER'
```

```
SQL>BTITLE CENTER CIT
```

```
SQL>select * from author;
```

```
Fri Jul 29
```

```
page 1
```

```
BOOK DEALER
```

```
AUTHOR_ID  NAME          CITY          COUNTRY
```

```
-----
```

```
1000 Nandagopalan Bangalore India
```

```
2000 Tony          Haywood USA
```

```
3000 Holzner      New York USA
```

```
4000 Tennenbaum   London UK
```

```
5000 Balaguruswamy Chennai India
```

```
CIT
```

CHAPTER – 2

LIBRARY DATABASE

1) Consider the following schema for a Library Database:

BOOK (Book_id, Title, Publisher_Name, Pub_Year)

BOOK_AUTHORS (Book_id, Author_Name)

PUBLISHER (Name, Address, Phone)

BOOK_COPIES (Book_id, Branch_id, No-of_Copies)

BOOK_LENDING (Book_id, Branch_id, Card_No, Date_Out, Due_Date)

LIBRARY_BRANCH (Branch_id, Branch_Name, Address)

Write SQL queries to

1. Retrieve details of all books in the library – id, title, name of publisher, authors, number of copies in each branch, etc.
2. Get the particulars of borrowers who have borrowed more than 3 books, but from Jan 2017 to Jun 2017
3. Delete a book in BOOK table. Update the contents of other tables to reflect this data manipulation operation.
4. Partition the BOOK table based on year of publication. Demonstrate its working with a simple query.
5. Create a view of all books and its number of copies that are currently available in the Library.

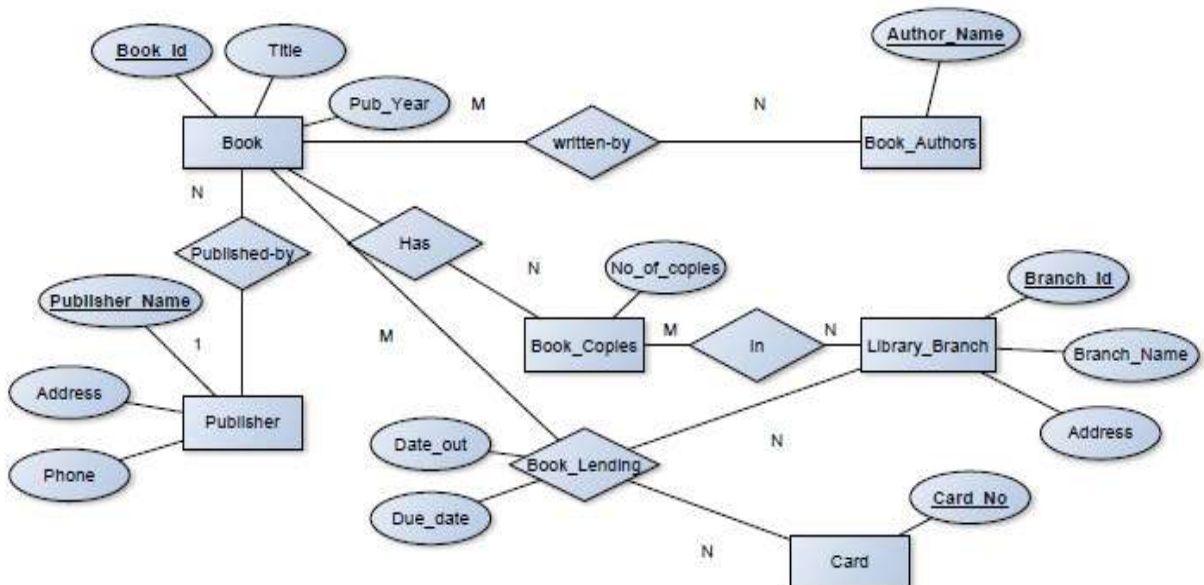
ER-Diagram:

SCHEMA:

Table Creation:**PUBLISHER**

```
SQL> CREATE TABLE PUBLISHER(  
    NAME VARCHAR(18) PRIMARY KEY,  
    ADDRESS VARCHAR(10),  
    PHONE VARCHAR(10));
```

Table created.

BOOK

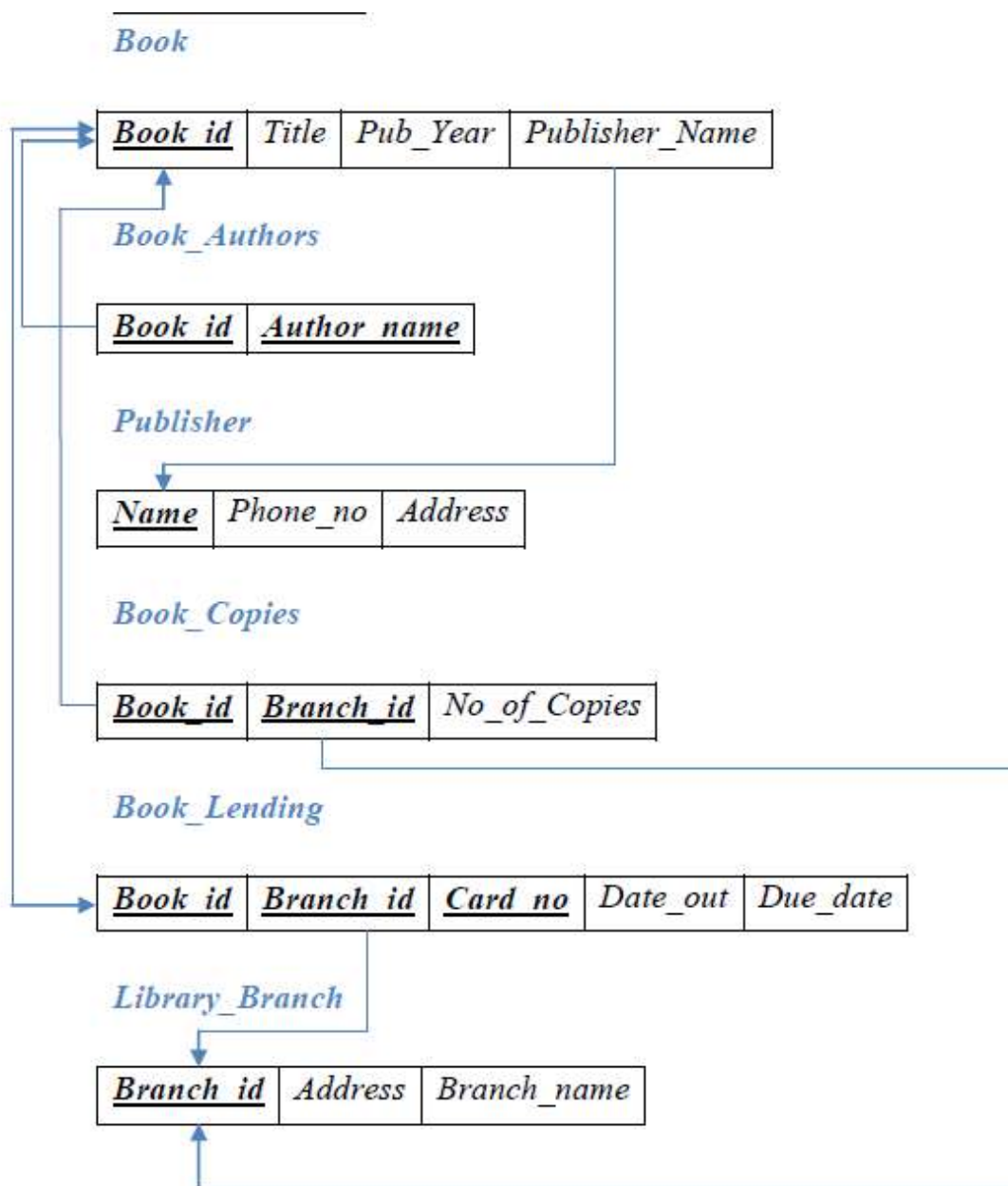
```
SQL> CREATE TABLE BOOK(  
    BOOK_ID INTEGER PRIMARY KEY,  
    TITLE VARCHAR(20),  
    PUBLISHER_NAME VARCHAR(20) REFERENCES PUBLISHER(NAME) ON DELETE  
    CASCADE,  
    PUB_YEAR NUMBER(4));
```

Table created.

BOOK_AUTHORS

```
SQL> CREATE TABLE BOOK_AUTHORS(  
    BOOK_ID INTEGER REFERENCES BOOK(BOOK_ID) ON DELETE CASCADE,  
    AUTHOR_NAME VARCHAR(20),  
    PRIMARY KEY(BOOK_ID));
```

Table created.

LIBRARY_BRANCH

```
SQL> CREATE TABLE LIBRARY_BRANCH(  
    BRANCH_ID INTEGER PRIMARY KEY,  
    BRANCH_NAME VARCHAR(18),  
    ADDRESS VARCHAR(15));
```

Table created.

BOOK_COPIES

```
SQL> CREATE TABLE BOOK_COPIES(  
    BOOK_ID INTEGER REFERENCES BOOK(BOOK_ID) ON DELETE CASCADE,  
    BRANCH_ID INTEGER REFERENCES LIBRARY_BRANCH(BRANCH_ID) ON DELETE  
    CASCADE,  
    NO_OF_COPIES INTEGER,  
    PRIMARY KEY(BOOK_ID, BRANCH_ID));
```

Table created.

BOOK_LENDING

```
SQL> CREATE TABLE BOOK_LENDING (  
    BOOK_ID INTEGER REFERENCES BOOK (BOOK_ID) ON DELETE CASCADE,  
    BRANCH_ID INTEGER REFERENCES LIBRARY_BRANCH (BRANCH_ID) ON DELETE  
                                CASCADE,  
    CARD_NO INTEGER,  
    DATE_OUT DATE,  
    DUE_DATE DATE,  
    PRIMARY KEY (BOOK_ID, BRANCH_ID, CARD_NO) );
```

Table created.

Values for tables:**PUBLISHER**

```
SQL> INSERT INTO PUBLISHER VALUES ('PEARSON', 'BANGALORE', '9875462530');  
SQL> INSERT INTO PUBLISHER VALUES ('MCGRAW', 'NEWDELHI', '7845691234');  
SQL> INSERT INTO PUBLISHER VALUES ('SAPNA', 'BANGALORE', '7845963210');
```

BOOK

```
SQL> INSERT INTO BOOK VALUES (1111, 'SE', 'PEARSON', 2005);  
SQL> INSERT INTO BOOK VALUES (2222, 'DBMS', 'MCGRAW', 2004);  
SQL> INSERT INTO BOOK VALUES (3333, 'ANATOMY', 'PEARSON', 2010);  
SQL> INSERT INTO BOOK VALUES (4444, 'ENCYCLOPEDIA', 'SAPNA', 2010);
```

BOOK_AUTHORS

```
SQL> INSERT INTO BOOK_AUTHORS VALUES (1111, 'SOMMERVILLE');  
SQL> INSERT INTO BOOK_AUTHORS VALUES (2222, 'NAVATHE');  
SQL> INSERT INTO BOOK_AUTHORS VALUES (3333, 'HENRY GRAY');  
SQL> INSERT INTO BOOK_AUTHORS VALUES (4444, 'THOMAS');
```

LIBRARY_BRANCH

```
SQL> INSERT INTO LIBRARY_BRANCH VALUES (11, 'CENTRAL TECHNICAL', 'MG ROAD');
```

```
SQL> INSERT INTO LIBRARY_BRANCH VALUES (22, 'MEDICAL', 'BH ROAD');
```

```
SQL> INSERT INTO LIBRARY_BRANCH VALUES (33, 'CHILDREN', 'SS PURAM');
```

```
SQL> INSERT INTO LIBRARY_BRANCH VALUES (44, 'SECRETARIAT', 'SIRAGATE');
```

```
SQL> INSERT INTO LIBRARY_BRANCH VALUES (55, 'GENERAL', 'JAYANAGAR');
```

BOOK_COPIES

```
SQL> INSERT INTO BOOK_COPIES VALUES (1111, 11, 5);
```

```
SQL> INSERT INTO BOOK_COPIES VALUES (3333, 22, 6);
```

```
SQL> INSERT INTO BOOK_COPIES VALUES (4444, 33, 10);
```

```
SQL> INSERT INTO BOOK_COPIES VALUES (2222, 11, 12);
```

```
SQL> INSERT INTO BOOK_COPIES VALUES (4444, 55, 3);
```

BOOK_LENDING

```
SQL> INSERT INTO BOOK_LENDING VALUES (2222, 11, 1, '10-JAN-2017', '20-AUG-2017');
```

```
SQL> INSERT INTO BOOK_LENDING VALUES (3333, 22, 2, '09-JUL-2017', '12-AUG-2017');
```

```
SQL> INSERT INTO BOOK_LENDING VALUES (4444, 55, 1, '11-APR-2017', '09-AUG-2017');
```

```
SQL> INSERT INTO BOOK_LENDING VALUES (2222, 11, 5, '09-AUG-2017', '19-AUG-2017');
```

```
SQL> INSERT INTO BOOK_LENDING VALUES (4444, 33, 1, '10-JUN-2017', '15-AUG-2017');
```

```
SQL> INSERT INTO BOOK_LENDING VALUES (1111, 11, 1, '12-MAY-2017', '10-JUN-2017');
```

```
SQL> INSERT INTO BOOK_LENDING VALUES (3333, 22, 1, '10-JUL-2017', '15-JUL-2017');
```

```
SQL> SELECT * FROM BOOK;
```

BOOK_ID	TITLE	PUBLISHER_NAME	PUB_YEAR
1111	SE	PEARSON	2005
2222	DBMS	MCGRAW	2004
3333	ANATOMY	PEARSON	2010
4444	ENCYCLOPEDIA	SAPNA	2010

```
4 rows selected.
```

```
SQL> SELECT * FROM BOOK_AUTHORS;
```

```
BOOK_ID AUTHOR_NAME
-----
1111 SOMMERVILLE
2222 NAVATHE
3333 HENRY GRAY
4444 THOMAS
```

4 rows selected.

```
SQL> SELECT * FROM PUBLISHER;
```

```
NAME ADDRESS PHONE
-----
PEARSON BANGALORE 9875462530
MCGRAW NEWDELHI 7845691234
SAPNA BANGALORE 7845963210
```

3 rows selected.

```
SQL> SELECT * FROM BOOK_COPIES;
```

```
BOOK_ID BRANCH_ID NO_OF_COPIES
-----
1111 11 5
3333 22 6
4444 33 10
2222 11 12
4444 55 3
```

5 rows selected.

```
SQL> SELECT * FROM BOOK_LENDING;
```

```
BOOK_ID BRANCH_ID CARD_NO DATE_OUT DUE_DATE
-----
2222 11 1 10-JAN-17 20-AUG-17
3333 22 2 09-JUL-17 12-AUG-17
4444 55 1 11-APR-17 09-AUG-17
2222 11 5 09-AUG-17 19-AUG-17
4444 33 1 10-JUL-17 15-AUG-17
1111 11 1 12-MAY-17 10-JUN-17
3333 22 1 10-JUL-17 15-JUL-17
```

7 rows selected.

```
SQL> SELECT * FROM LIBRARY_BRANCH;
```

BRANCH_ID	BRANCH_NAME	ADDRESS
11	CENTRAL TECHNICAL	MG ROAD
22	MEDICAL	BH ROAD
33	CHILDREN	SS PURAM
44	SECRETARIAT	SIRAGATE
55	GENERAL	JAYANAGAR

5 rows selected.

- 1) Retrieve details of all books in the library – id, title, name of publisher, authors, number of copies in each branch, etc.

```
SELECT LB.BRANCH_NAME, B.BOOK_ID, TITLE, PUBLISHER_NAME, AUTHOR_NAME,
        NO_OF_COPIES
FROM BOOK B, BOOK_AUTHORS BA, BOOK_COPIES BC, LIBRARY_BRANCH LB
WHERE B.BOOK_ID = BA.BOOK_ID AND
        BA.BOOK_ID = BC.BOOK_ID AND
        BC.BRANCH_ID = LB.BRANCH_ID
GROUP BY LB.BRANCH_NAME, B.BOOK_ID, TITLE, PUBLISHER_NAME,
        AUTHOR_NAME, NO_OF_COPIES;
```

BRANCH_NAME	BOOK_ID	TITLE	PUBLISHER_NAME	AUTHOR_NAME	NO_OF_COPIES
GENERAL	4444	ENCYCLOPEDIA	SAPNA	THOMAS	3
MEDICAL	3333	ANATOMY	PEARSON	HENRY GRAY	6
CHILDREN	4444	ENCYCLOPEDIA	SAPNA	THOMAS	10
CENTRAL TECHNICAL	1111	SE	PEARSON	SOMMERVILLE	5
CENTRAL TECHNICAL	2222	DBMS	MCGRAW	NAVATHE	12

- 2) Get the particulars of borrowers who have borrowed more than 3 books, but from Jan 2017 to Jun 2017.

```
SELECT CARD_NO
FROM BOOK_LENDING
WHERE DATE_OUT BETWEEN '01-JAN-2017' AND '30-JUN-2017'
GROUP BY CARD_NO
HAVING COUNT(*) > 3;
```

```
CARD_NO
-----
1
```

3) Delete a book in BOOK table. Update the contents of other tables to reflect this data manipulation operation.

```
DELETE FROM BOOK
WHERE BOOK_ID = '3333';
```

1 row deleted.

```
SQL> SELECT * FROM BOOK;
```

BOOK_ID	TITLE	PUBLISHER_NAME	PUB_YEAR
1111	SE	PEARSON	2005
2222	DBMS	MCGRAW	2004
4444	ENCYCLOPEDIA	SAPNA	2010

```
SQL> SELECT * FROM BOOK_COPIES;
```

BOOK_ID	BRANCH_ID	NO_OF_COPIES
1111	11	5
4444	33	10
2222	11	12
4444	55	3

```
SQL> SELECT * FROM BOOK_LENDING;
```

BOOK_ID	BRANCH_ID	CARD_NO	DATE_OUT	DUE_DATE
2222	11	1	10-JAN-17	20-AUG-17
4444	55	1	11-APR-17	09-AUG-17
2222	11	5	09-AUG-17	19-AUG-17
4444	33	1	10-JUN-17	15-AUG-17
1111	11	1	12-MAY-17	10-JUN-17

4) Partition the BOOK table based on year of publication. Demonstrate its working with a simple query.

```
SELECT BOOK_ID, TITLE, PUBLISHER_NAME, PUB_YEAR
FROM BOOK
GROUP BY PUB_YEAR, BOOK_ID, TITLE, PUBLISHER_NAME;
```

BOOK_ID	TITLE	PUBLISHER_NAME	PUB_YEAR
2222	DBMS	MCGRAW	2004
1111	SE	PEARSON	2005
3333	ANATOMY	PEARSON	2010
4444	ENCYCLOPEDIA	SAPNA	2010

5) Create a view of all books and its number of copies that are currently available in the Library.

```
CREATE VIEW BOOKS_AVAILABLE AS  
SELECT B.BOOK_ID, B.TITLE, C.NO_OF_COPIES  
FROM LIBRARY_BRANCH L, BOOK B, BOOK_COPIES C  
WHERE B.BOOK_ID = C.BOOK_ID AND  
L.BRANCH_ID=C.BRANCH_ID;
```

View created.

```
SQL> SELECT * FROM BOOKS_AVAILABLE;
```

BOOK_ID	TITLE	NO_OF_COPIES
1111	SE	5
3333	ANATOMY	6
4444	ENCYCLOPEDIA	10
2222	DBMS	12
4444	ENCYCLOPEDIA	3

DATE:

SIGNATURE

CHAPTER – 3

ORDER DATABASE

2) Consider the following schema for Order Database:

SALESMAN (Salesman_id, Name, City, Commission)

CUSTOMER (Customer_id, Cust_Name, City, Grade, Salesman_id)

ORDERS (Ord_No, Purchase_Amt, Ord_Date, Customer_id, Salesman_id)

Write SQL queries to

- Count the customers with grades above Bangalore's average.
- Find the name and numbers of all salesmen who had more than one customer.
- List all salesmen and indicate those who have and don't have customers in their cities (Use UNION operation.)
- Create a view that finds the salesman who has the customer with the highest order of a day.
- Demonstrate the DELETE operation by removing salesman with id 1000. All his orders must also be deleted.

ER-Diagram:

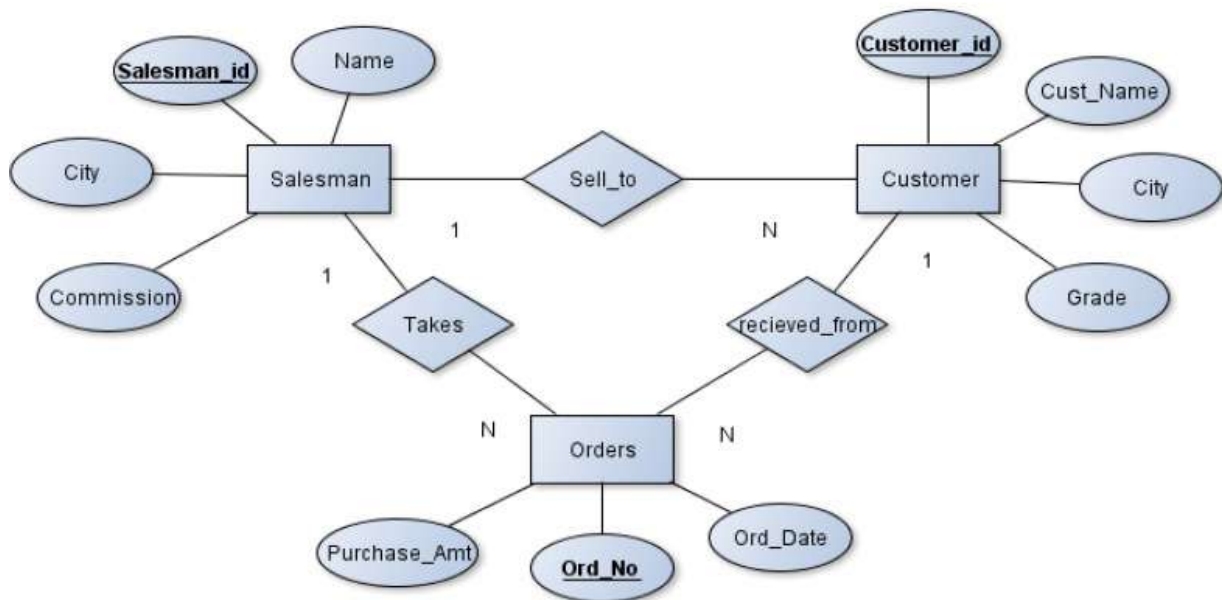

SCHEMA:

Table Creation:**SALESMAN**

```
CREATE TABLE SALESMAN(  
SALESMAN_ID NUMBER(5) CONSTRAINT SALESMAN_SALID PRIMARY KEY,  
NAME VARCHAR(10) CONSTRAINT SALESMAN_NAME_NN NOT NULL,  
CITY VARCHAR(15) CONSTRAINT SALESMAN_CITY_NN NOT NULL,  
COMMISSION NUMBER(5));
```

Table created.

CUSTOMER

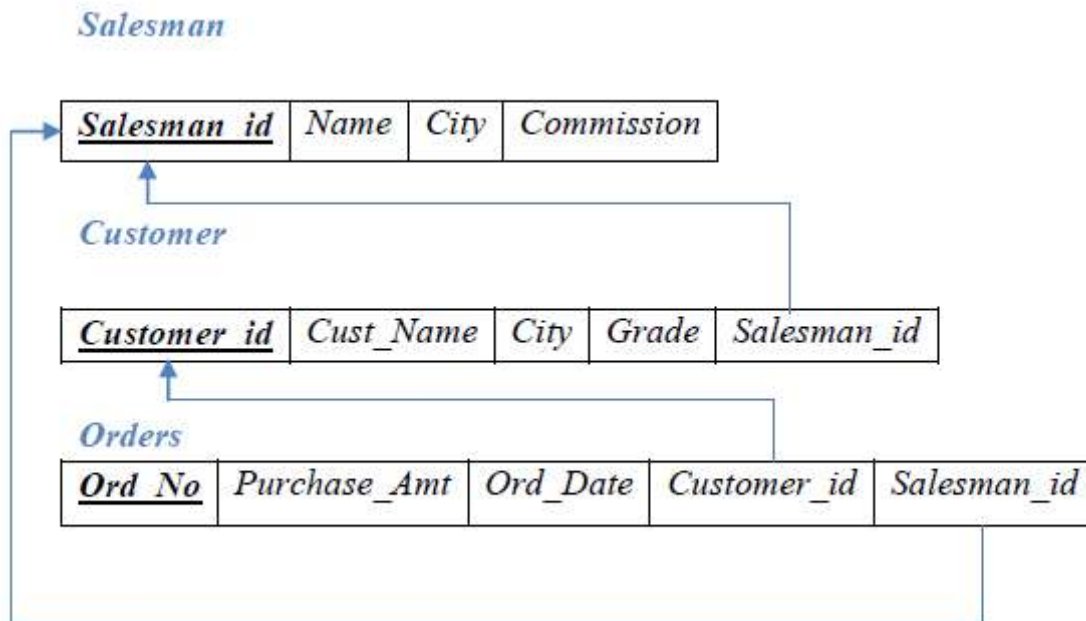
```
CREATE TABLE CUSTOMER(  
CUSTOMER_ID NUMBER(5) CONSTRAINT CUSTOMER_CUSTID_PK PRIMARY KEY,  
CUST_NAME VARCHAR(10) CONSTRAINT CUSTOMER_CUSTNAME_NN NOT NULL,  
CITY VARCHAR(10) CONSTRAINT CUSTOMER_CITY_NN NOT NULL,  
GRADE NUMBER(5) CONSTRAINT CUSTOMER_GRADE_NN NOT NULL,  
SALESMAN_ID NUMBER(5) CONSTRAINT CUSTOMER_SALEID_FK REFERENCES  
SALESMAN(SALESMAN_ID) ON DELETE SET NULL);
```

Table created.

ORDERS

```
CREATE TABLE ORDERS(  
ORD_NO NUMBER(5) CONSTRAINT ORDERS_ODNO_PK PRIMARY KEY,  
PURCHASE_AMT INTEGER CONSTRAINT ORDERS_PAMT_NN NOT NULL,  
ORD_DATE DATE CONSTRAINT ORDERS_ODATE_NN NOT NULL,  
CUSTOMER_ID NUMBER(5) CONSTRAINT ORDERS_CUSTID_FK REFERENCES  
CUSTOMER(CUSTOMER_ID),  
SALESMAN_ID NUMBER(5) CONSTRAINT ORDERS_SALEID_FK REFERENCES  
SALESMAN(SALESMAN_ID) ON DELETE CASCADE);
```

Table created.

Values for tables

```
SQL> INSERT INTO SALESMAN VALUES (&SALESMAN_ID, '&NAME', '&CITY', &COMMISSION);
```

```
SQL> INSERT INTO CUSTOMER  
VALUES (&CUSTOMER_ID, '&CUST_NAME', '&CITY', '&GRADE', &SALESMAN_ID);
```

```
SQL> INSERT INTO ORDERS  
VALUES (&ORD_NO, &PURCHASE_AMT, '&ORD_DATE', &CUSTOMER_ID, &SALESMAN_ID);
```

```
SELECT * FROM SALESMAN;
```

SALESMAN_ID	NAME	CITY	COMMISSION
1000	RAJ	BENGALURU	50
2000	ASHWIN	TUMKUR	30
3000	BINDU	MUMBAI	40
4000	LAVANYA	BENGALURU	40
5000	ROHIT	MYSORE	60

```
SELECT * FROM CUSTOMER;
```

CUSTOMER_ID	CUST_NAME	CITY	GRADE	SALESMAN_ID
11	INFOSYS	BENGALURU	5	1000
22	TCS	BENGALURU	4	2000
33	WIPRO	MYSORE	7	1000
44	TCS	MYSORE	6	2000
55	ORACLE	TUMKUR	3	3000

```
SELECT * FROM ORDERS;
```

ORD_NO	PURCHASE_AMT	ORD_DATE	CUSTOMER_ID	SALESMAN_ID
1	200000	12-APR-16	11	1000
2	300000	12-APR-16	11	2000
3	400000	15-APR-17	22	1000

- Count the customers with grades above Bangalore's average.

```
SELECT COUNT(CUSTOMER_ID)
FROM CUSTOMER
WHERE GRADE > (SELECT AVG(GRADE)
FROM CUSTOMER
WHERE CITY LIKE '%BENGALURU');
```

```
COUNT(CUSTOMER_ID)
```

```
-----
3
```

2. Find the name and numbers of all salesmen who had more than one customer.

```

SELECT NAME, COUNT (CUSTOMER_ID)
FROM SALESMAN S, CUSTOMER C
WHERE S.SALESMAN_ID=C.SALESMAN_ID
GROUP BY NAME
HAVING COUNT (CUSTOMER_ID)>1;

```

```

NAME          COUNT (CUSTOMER_ID)
-----
ASHWIN                2
RAJ                   2

```

3. List all salesmen and indicate those who have and don't have customers in their cities (Use UNION operation.)

```

(SELECT NAME
FROM SALESMAN S, CUSTOMER C
WHERE S.SALESMAN_ID=C.SALESMAN_ID AND
      S.CITY=C.CITY)
UNION
(SELECT NAME
FROM SALESMAN
WHERE SALESMAN_ID NOT IN (SELECT S1.SALESMAN_ID
                           FROM SALESMAN S1, CUSTOMER C1
                           WHERE S1.SALESMAN_ID=C1.SALESMAN_ID AND
                           S1.CITY=C1.CITY));

```

```

NAME
-----
ASHWIN
BINDU
LAVANYA
RAJ
ROHIT

```

4. Create a view that finds the salesman who has the customer with the highest order of a day.

```

CREATE VIEW SALES_HIGHERODER AS
SELECT SALESMAN_ID, PURCHASE_AMT
FROM ORDERS
WHERE PURCHASE_AMT=(SELECT MAX (O.PURCHASE_AMT)
                    FROM ORDERS O
                    WHERE O.ORD_DATE='12-APR-16');

```

View created.

```

SELECT * FROM SALES_HIGHERODER;

```

```

SALESMAN_ID PURCHASE_AMT
-----
          2000      300000

```

5. Demonstrate the DELETE operation by removing salesman with id 1000. All his orders must also be deleted.

Delete from salesman
Where salesman_id = 1000;

1 row deleted

SELECT * FROM SALESMAN;

SALESMAN_ID	NAME	CITY	COMMISSION
2000	ASHWIN	TUMKUR	30
3000	BINDU	MUMBAI	40
4000	LAVANYA	BENGALURU	40
5000	ROHIT	MYSORE	60

SELECT * FROM CUSTOMER;

CUSTOMER_ID	CUST_NAME	CITY	GRADE	SALESMAN_ID
11	INFOSYS	BENGALURU	5	
22	TCS	BENGALURU	4	2000
33	WIPRO	MYSORE	7	
44	TCS	MYSORE	6	2000
55	ORACLE	TUMKUR	3	3000

SELECT * FROM ORDERS;

ORD_NO	PURCHASE_AMT	ORD_DATE	CUSTOMER_ID	SALESMAN_ID
2	300000	12-APR-16	11	2000

DATE:

SIGNATURE

CHAPTER – 4

MOVIE DATABASE

3) Consider the schema for Movie Database:

ACTOR (Act_id, Act_Name, Act_Gender)

DIRECTOR (Dir_id, Dir_Name, Dir_Phone)

MOVIES (Mov_id, Mov_Title, Mov_Year, Mov_Lang, Dir_id)

MOVIE_CAST (Act_id, Mov_id, Role)

RATING (Mov_id, Rev_Stars)

Write SQL queries to

1. List the titles of all movies directed by 'Hitchcock'.
2. Find the movie names where one or more actors acted in two or more movies.
3. List all actors who acted in a movie before 2000 and also in a movie after 2015 (use JOIN operation).
4. Find the title of movies and number of stars for each movie that has at least one rating and find the highest number of stars that movie received. Sort the result by movie title.
5. Update rating of all movies directed by 'Steven Spielberg' to 5.

ER-Diagram:

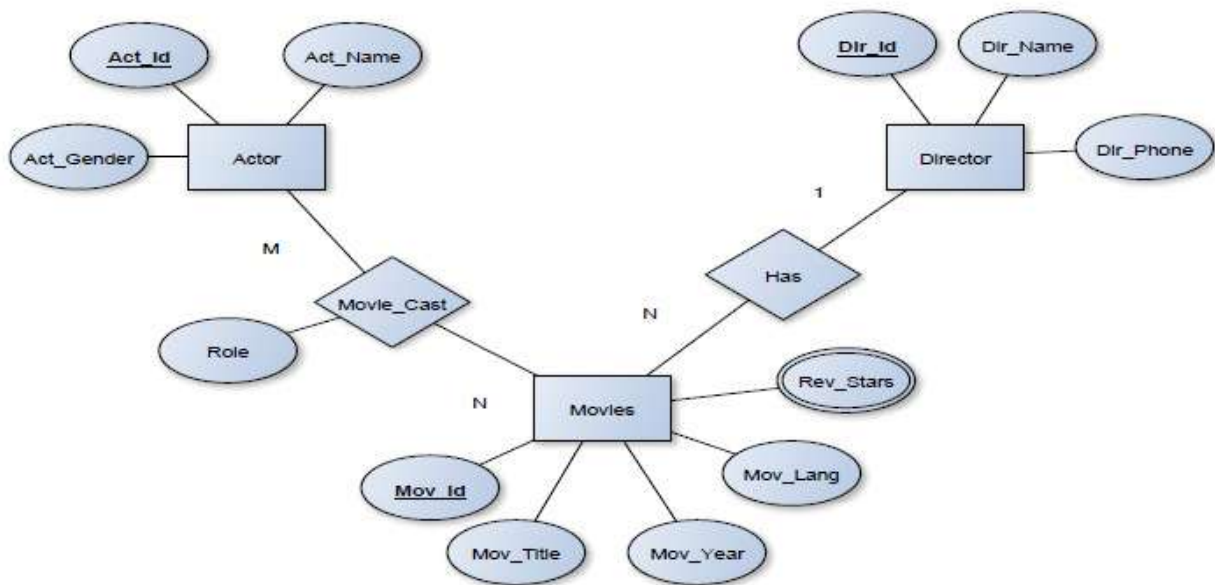

SCHEMA:

Table Creation:**ACTOR**

```
SQL> CREATE TABLE ACTOR (
  2  ACT_ID NUMBER(5) CONSTRAINT ACTOR_ACTID_PK PRIMARY KEY,
  3  ACT_NAME VARCHAR(15) CONSTRAINT ACTOR_ACTNAME_NN NOT NULL,
  4  ACT_GENDER VARCHAR(2) CONSTRAINT ACTOR_ACTGENDER_NN NOT NULL);
```

Table created.

DIRECTOR

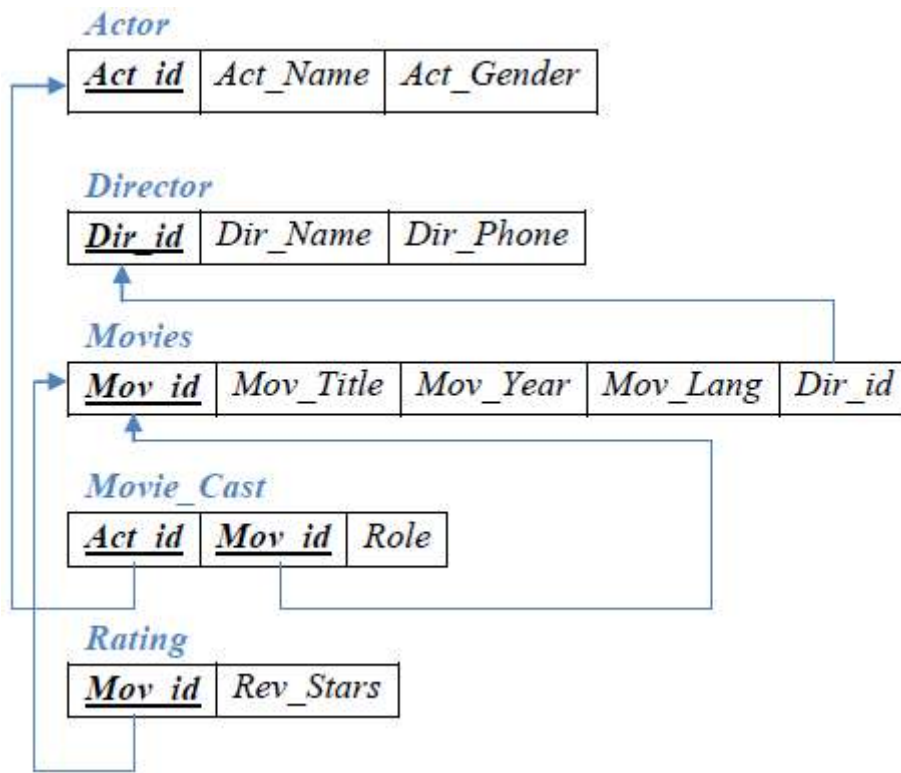
```
SQL> CREATE TABLE DIRECTOR (
  2  DIR_ID NUMBER(5) CONSTRAINT DIRECTOR_DIRID_PK PRIMARY KEY,
  3  DIR_NAME VARCHAR(10) CONSTRAINT DIRECTOR_DIRNAME_NN NOT NULL,
  4  DIR_PHONE INTEGER CONSTRAINT DIRECTOR_DIRPHONE_NN NOT NULL);
```

Table created.

MOVIES

```
SQL> CREATE TABLE MOVIES (
  2  MOV_ID NUMBER(5) CONSTRAINT MOVIES_MOVID_PK PRIMARY KEY,
  3  MOV_TITLE VARCHAR(10) CONSTRAINT MOVIES_MOVTITLE_NN NOT NULL,
  4  MOV_YEAR NUMBER(5) CONSTRAINT MOVIES_MOVYEAR_NN NOT NULL,
  5  MOV_LANG VARCHAR(10) CONSTRAINT MOVIES_MOVLANG_NN NOT NULL,
  6  DIR_ID NUMBER(5) CONSTRAINT MOVIES_DIRID_FK REFERENCES
DIRECTOR(DIR_ID));
```

Table created.

MOVIE_CAST

```
SQL> CREATE TABLE MOVIE_CAST (
  2  ACT_ID NUMBER(5) CONSTRAINT MOVIECAST_ACTID_FK REFERENCES ACTOR(ACT_ID),
  3  MOV_ID NUMBER(5) CONSTRAINT MOVIECAST_MOVID_FK REFERENCES MOVIES(MOV_ID),
  4  ROLE VARCHAR(10),
  5  CONSTRAINT MOVIECAST_ACTID_MOVID_PK PRIMARY KEY(ACT_ID,MOV_ID));
```

Table created.

RATING

```
SQL> CREATE TABLE RATING (
  2  MOV_ID NUMBER(5) CONSTRAINT RATING_MOVID_FK REFERENCES MOVIES(MOV_ID),
  3  REV_STARS NUMBER(1) CONSTRAINT RATING_REVSTARS_NN NOT NULL,
  4  CONSTRAINT RATING_MOVID_PK PRIMARY KEY(MOV_ID))
```

Table created.

Description of Schema:

SQL> DESC ACTOR

Name	Null?	Type
ACT_ID	NOT NULL	NUMBER (5)
ACT_NAME	NOT NULL	VARCHAR2 (15)
ACT_GENDER	NOT NULL	VARCHAR2 (2)

SQL> DESC DIRECTOR

Name	Null?	Type
DIR_ID	NOT NULL	NUMBER (5)
DIR_NAME	NOT NULL	VARCHAR2 (18)
DIR_PHONE	NOT NULL	VARCHAR (10)

SQL> DESC MOVIES

Name	Null?	Type
MOV_ID	NOT NULL	NUMBER (5)
MOV_TITLE	NOT NULL	VARCHAR2 (10)
MOV_YEAR	NOT NULL	NUMBER (5)
MOV_LANG	NOT NULL	VARCHAR2 (10)
DIR_ID		NUMBER (5)

SQL> DESC RATING

Name	Null?	Type
MOV_ID	NOT NULL	NUMBER (5)
REV_STARS	NOT NULL	NUMBER (1)

Values for tables:SQL> **INSERT INTO** ACTOR **VALUES** (&ACT_ID, '&ACT_NAME', '&ACT_GENDER');SQL> **INSERT INTO** DIRECTOR **VALUES** (&DIR_ID, '&DIR_NAME', &DIR_PHONE);SQL> **INSERT INTO** MOVIES
VALUES (&MOV_ID, '&MOV_TITLE', '&MOV_YEAR', '&MOV_LANG', &DIR_ID);SQL> **INSERT INTO** MOVIE_CAST **VALUES** (&ACT_ID, &MOV_ID, '&ROLE');SQL> **INSERT INTO** RATING **VALUES** (&MOV_ID, &REV_STARS);

SQL> SELECT * FROM ACTOR;

ACT_ID	ACT_NAME	AC
111	DEEPA SANNIDHI	F
222	SUDEEP	M

333	PUNEETH	M
444	DHIGANTH	M
555	ANGELA	F

SQL> SELECT * FROM DIRECTOR;

DIR_ID	DIR_NAME	DIR_PHONE
101	HITCHCOCK	112267809
102	RAJ MOULI	152358709
103	YOGARAJ	272337808
104	STEVEN SPIELBERG	363445678
105	PAVAN KUMAR	385456809

SQL> SELECT * FROM MOVIES;

MOV_ID	MOV_TITLE	MOV_YEAR	MOV_LANG	DIR_ID
1111	LASTWORLD	2009	ENGLISH	104
2222	EEGA	2010	TELUGU	102
4444	PARAMATHMA	2012	KANNADA	103
3333	MALE	2006	KANNADA	103
5555	MANASARE	2010	KANNADA	103
6666	REAR WINDOW	1954	ENGLISH	101
7777	NOTORIOUS	1946	ENGLISH	101

SQL> SELECT * FROM MOVIE_CAST;

ACT_ID	MOV_ID	ROLE
222	2222	VILAN
333	4444	HERO
111	4444	HEROIN
444	3333	GUEST
444	5555	HERO
555	7777	MOTHER

SQL> SELECT * FROM RATING;

MOV_ID	REV_STARS
1111	3
2222	4
3333	3
5555	4
4444	5

1. List the titles of all movies directed by 'Hitchcock'.

```

SELECT MOV_TITLE
FROM MOVIES M, DIRECTOR D
WHERE D.DIR_ID=M.DIR_ID AND

```

```
DIR_NAME='HITCHCOCK';
```

```
MOV_TITLE
-----
NOTORIOUS
REAR WINDOW
```

2. Find the movie names where one or more actors acted in two or more movies.

```
SELECT MOV_TITLE
FROM MOVIES M, MOVIE_CAST MC
WHERE M.MOV_ID=MC.MOV_ID AND
      MC.ACT_ID IN (SELECT ACT_ID
                   FROM MOVIE_CAST
                   GROUP BY ACT_ID
                   HAVING COUNT(MOV_ID) >=2);
```

```
MOV_TITLE
-----
MALE
MANASARE
```

3. List all actors who acted in a movie before 2000 and also in a movie after 2015 (use JOIN operation).

```
SELECT ACT_NAME
FROM ACTOR A
JOIN MOVIE_CAST C
  ON A.ACT_ID=C.ACT_ID
JOIN MOVIES M
  ON C.MOV_ID=M.MOV_ID
WHERE M.MOV_YEAR NOT BETWEEN 2000 AND 2015;
```

```
ACT_NAME
-----
DHIGANTH
```

4. Find the title of movies and number of stars for each movie that has at least one rating and find the highest number of stars that movie received. Sort the result by movie title.

```
SELECT MOV_TITLE, REV_STARS
FROM MOVIES M, RATING R
WHERE M.MOV_ID=R.MOV_ID AND REV_STARS >=1
ORDER BY MOV_TITLE
```

```
MOV_TITLE  REV_STARS
-----  -----
EEGA                4
LASTWORLD           3
MALE                3
MANASARE            4
```

5. Update rating of all movies directed by 'Steven Spielberg' to 5.

```
UPDATE RATING
SET REV_STARS=5
WHERE MOV_ID IN (SELECT MOV_ID
FROM MOVIES M, DIRECTOR D
WHERE M.DIR_ID=D.DIR_ID AND
DIR_NAME='STEVEN SPIELBERG');
```

1 row updated.

```
SELECT * FROM RATING
```

```
MOV_ID REV_STARS
-----
1111    5
2222    4
3333    3
5555    4
4444    5
```

DATE:

SIGNATURE

CHAPTER - 5 COLLEGE DATABASE

4). Consider the schema for College Database:

STUDENT (USN, SName, Address, Phone, Gender)

SEMSEC (SSID, Sem, Sec)

CLASS (USN, SSID)

SUBJECT (Subcode, Title, Sem, Credits)

IAMARKS (USN, Subcode, SSID, Test1, Test2, Test3, FinalIA)

Write SQL queries to

1. List all the student details studying in fourth semester 'C' section.
 2. Compute the total number of male and female students in each semester and in each section.
 3. Create a view of Test1 marks of student USN '1BI15CS101' in all subjects.
 4. Calculate the FinalIA (average of best two test marks) and update the corresponding table for all students.
 5. Categorize students based on the following criterion:
 - If FinalIA = 17 to 20 then CAT = 'Outstanding'
 - If FinalIA = 12 to 16 then CAT = 'Average'
 - If FinalIA < 12 then CAT = 'Weak'
- Give these details only for 8th semester A, B, and C section students.

ER-Diagram:

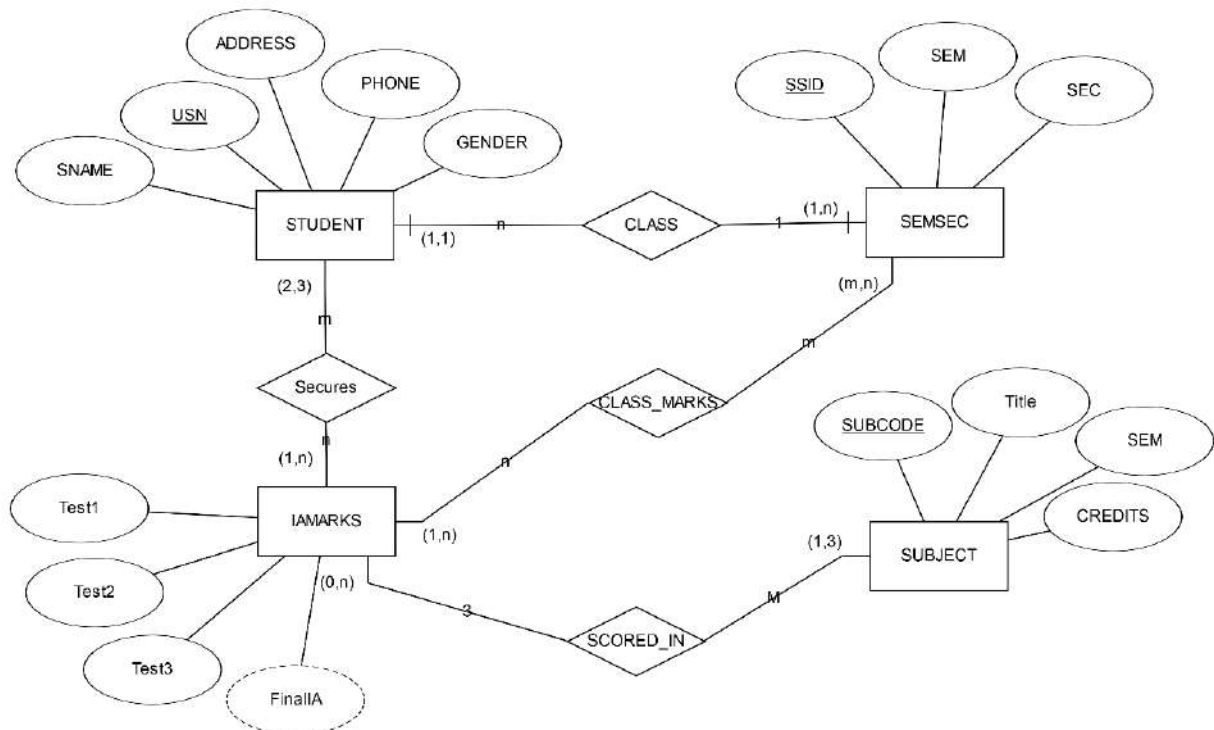

SCHEMA:

Table Creation:**STUDENT**

```
CREATE TABLE STUDENT
(USN VARCHAR(10) PRIMARY KEY,
SNAME VARCHAR(25),
ADDRESS VARCHAR(25),
PHONE VARCHAR(10),
GENDER CHAR(1));
```

Table created.

SEMSEC

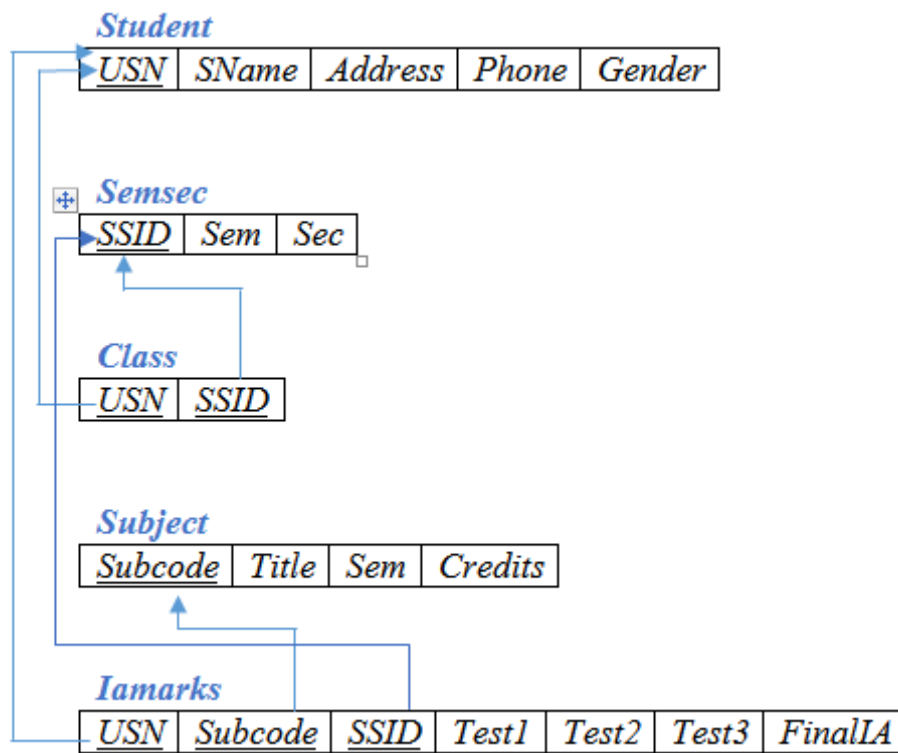
```
CREATE TABLE SEMSEC
SSID VARCHAR(5) PRIMARY KEY,
SEM NUMBER(2),
SEC CHAR(1);
```

Table created.

CLASS

```
CREATE TABLE CLASS
(USN VARCHAR(10),
SSID VARCHAR(5),
PRIMARY KEY (USN, SSID),
FOREIGN KEY (USN) REFERENCES STUDENT (USN),
FOREIGN KEY (SSID) REFERENCES SEMSEC (SSID));
```

Table created.

SUBJECT

```
CREATE TABLE SUBJECT
(SUBCODE VARCHAR(8) PRIMARY KEY,
TITLE VARCHAR(20),
SEM NUMBER(2),
CREDITS NUMBER(2));
```

Table created.

IAMARKS

```
CREATE TABLE IAMARKS
(USN VARCHAR(10),
SUBCODE VARCHAR(8),
SSID VARCHAR(5),
TEST1 NUMBER(2),
TEST2 NUMBER(2),
```

```

TEST3 NUMBER(2),
FINALIA NUMBER(3),
PRIMARY KEY (USN, SUBCODE, SSID),
FOREIGN KEY (USN) REFERENCES STUDENT (USN),
FOREIGN KEY (SUBCODE) REFERENCES SUBJECT (SUBCODE),
FOREIGN KEY (SSID) REFERENCES SEMSEC (SSID);

```

Table created.

Values for tables:

STUDENT :

```

INSERT INTO STUDENT VALUES
('&USN', '&sname', '&address', '&phone', '&gender');

```

```
select * from student;
```

USN	SNAME	ADDRESS	PHONE	G
1cg15cs001	abhi	tumkur	9875698410	M
1cg15cs002	amulya	gubbi	8896557412	F
1cg16me063	chethan	nittur	7894759522	M
1cg14ec055	raghavi	sspuram	9485675521	F
1cg15ee065	sanjay	bangalore	9538444404	M

SEMSEC :

```
INSERT INTO SEMSEC VALUES ('&SSID', '&sem', '&sec');
```

```
select * from semsec;
```

SSID	SEM	S
5A	5	A
3B	3	B
7A	7	A
2C	2	C
4B	4	B
4c	4	c

CLASS :

```
INSERT INTO CLASS VALUES ('&USN', '&SSID');
```

```
select * from class;
```

USN	SSID
1cg15cs001	5A
1cg15cs002	5A

```
1cg16me063 3B
1cg14ec055 7A
1cg15ee065 3B
1cg15ee065 4c
1cg15cs002 4c
```

SUBJECT:

```
INSERT INTO SUBJECT VALUES ('10CS81','ACA', 8, 4);
```

```
select * from subject;
```

SUBCODE	TITLE	SEM	CREDITS
15cs53	dbms	5	4
15cs33	ds	3	4
15cs34	co	3	4
15cs158	dba	52	
10cs71	oomd	7	4

IAMARKS:

```
INSERT INTO IAMARKS VALUES
('&USN', '&SUBCODE', '&SSID', '&TEST1', '&TEST2', '&TEST3');
```

```
select * from iamarks;
```

USN	SUBCODE	SSID	TEST1	TEST2	TEST3	FINALIA
1cg15cs001	15cs53	5A	18	19	15	19
1cg15cs002	15cs53	5A	15	16	14	16
1cg16me063	15cs33	3B	10	15	16	16
1cg14ec055	10cs71	7A	18	20	21	21
1cg15ee065	15cs33	3B	16	20	17	19
1cg15ee065	15cs53	4c	19	20	18	20

Queries:**1. List all the student details studying in fourth semester 'C' section.**

```
select s.usn, sname, address, phone, gender
from student s, class c, semsec ss
where sem=4 and
      sec='c' and
      ss.ssid=c.ssid and
      c.usn=s.usn;
```

USN	SNAME	ADDRESS	PHONE	G
1cg15ee065	sanjay	bangalore	9538444404	M
1cg15cs002	amulya	gubbi	8896557412	F

2. Compute the total number of male and female students in each semester and in each section.

```
SELECT SEM, SEC, GENDER, COUNT (*)
FROM STUDENT S, SEMSEC SS, CLASS C
WHERE S.USN=C.USN AND
      C.SSID=SS.SSID
GROUP BY SEM, SEC, GENDER
ORDER BY SEM;
```

SEM	S	G	COUNT (*)
3	B	M	2
4	c	F	1
4	c	M	1
5	A	F	1
5	A	M	1
7	A	F	1

3. Create a view of Test1 marks of student USN '1BI15CS101' in all subjects.

```
CREATE VIEW TEST1 AS
SELECT SUBCODE, TEST1
FROM IAMARKS
WHERE USN='1cg15ee065';
```

View created.

```
SQL> select * from test1;
```

SUBCODE	TEST1
15cs33	16
15cs53	19

4. Calculate the FinalIA (average of best two test marks) and update the corresponding table for all students.

```
CREATE OR REPLACE PROCEDURE AVG
IS
CURSOR C_IAMARKS IS
SELECT GREATEST(TEST1, TEST2) AS A, GREATEST(TEST1, TEST3) AS B,
      GREATEST(TEST3, TEST2) AS C
FROM IAMARKS
WHERE FINALIA IS NULL
FOR UPDATE;
```

```

C_A NUMBER;
      C_B NUMBER;
C_C NUMBER;
C_SM NUMBER;
C_AV NUMBER;
BEGIN
OPEN C_IAMARKS;
LOOP
FETCH C_IAMARKS INTO C_A,C_B,C_C;
EXIT WHEN C_IAMARKS%NOTFOUND;
DBMS_OUTPUT.PUT_LINE(C_A||' '||C_B||' '||C_C);
  IF(C_A!=C_B) THEN
C_SM:=C_A+C_B;
ELSE
      C_SM:=C_A+C_C;
END IF;
C_AV:=C_SM/2;
DBMS_OUTPUT.PUT_LINE('SUM='||C_SM);
DBMS_OUTPUT.PUT_LINE('AVERAGE='||C_AV);
UPDATE IAMARKS
SET FINALIA=C_AV
WHERE CURRENT OF C_IAMARKS;
END LOOP;
CLOSE C_IAMARKS;
END AVG;

```

Procedure created.

```

SQL> BEGIN
      AVG;
      END;

```

PL/SQL procedure successfully completed.

```

SQL> SELECT * FROM IAMARKS;

```

USN	SUBCODE	SSID	TEST1	TEST2	TEST3	FINALIA
1cg15cs001	15cs53	5A	18	19	15	19
1cg15cs002	15cs53	5A	15	16	14	16
1cg16me063	15cs33	3B	10	15	16	16
1cg14ec055	10cs71	7A	18	20	21	21
1cg15ee065	15cs33	3B	16	20	17	19
1cg15ee065	15cs53	4c	19	20	18	20

6 rows selected.

5. Categorize students based on the following criterion:**If FinalIA = 17 to 20 then CAT = 'Outstanding'****If FinalIA = 12 to 16 then CAT = 'Average'****If FinalIA < 12 then CAT = 'Weak'****Give these details only for 8th semester A, B, and C section students.**

```
SELECT S.USN, S.SNAME, S.ADDRESS, S.PHONE, S.GENDER,
CASE WHEN IA.FINALIA BETWEEN 17 AND 20 THEN 'OUTSTANDING'
WHEN IA.FINALIA BETWEEN 12 AND 16 THEN 'AVERAGE'
ELSE 'WEAK'
END AS CAT
FROM STUDENT S, SEMSEC SS, IAMARKS IA, SUBJECT SUB
WHERE S.USN=IA.USN AND
      SS.SSID=IA.SSID AND
      SUB.SUBCODE=IA.SUBCODE AND
      SUB.SEM=7
```

USN	SNAME	ADDRESS	PHONE	G	CAT
1cg14ec055	raghavi	sspuram	9485675521	F	WEAK

DATE:

SIGNATURE

CHAPTER – 6

COMPANY DATABASE

5). Consider the schema for Company Database:

EMPLOYEE (SSN, Name, Address, Sex, Salary, SuperSSN, DNo)

DEPARTMENT (DNo, DName, MgrSSN, MgrStartDate)

DLOCATION (DNo, DLoc)

PROJECT (PNo, PName, PLocation, DNo)

WORKS_ON (SSN, PNo, Hours)

Write SQL queries to

1. Make a list of all project numbers for projects that involve an employee whose last name is 'Scott', either as a worker or as a manager of the department that controls the project.
2. Show the resulting salaries if every employee working on the 'IoT' project is given a 10 percent raise.
3. Find the sum of the salaries of all employees of the 'Accounts' department, as well as the maximum salary, the minimum salary, and the average salary in this department.
4. Retrieve the name of each employee who works on all the projects controlled by department number 5 (use NOT EXISTS operator).
5. For each department that has more than five employees, retrieve the department number and the number of its employees who are making more than Rs. 6,00,000.

ER-DIAGRAM:

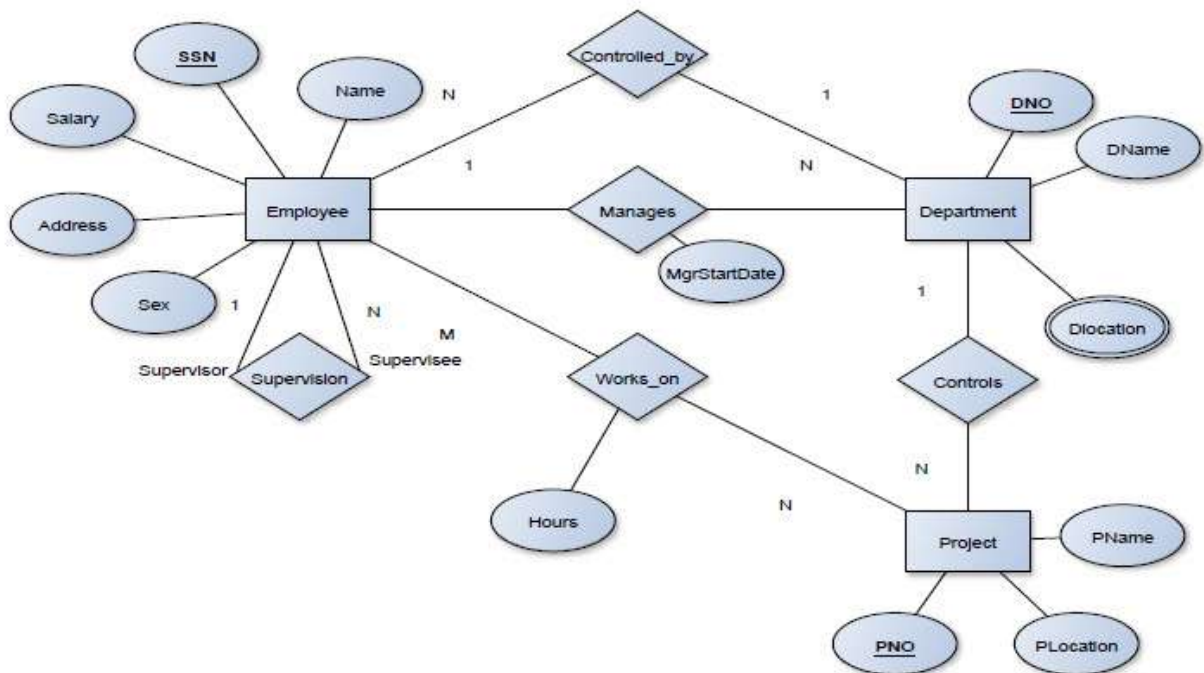

SCHEMA:

Table Creation:**DEPARTMENT**

```
CREATE TABLE DEPARTMENT (  
DNO NUMBER(3) CONSTRAINT DEPT_DNO_PK PRIMARY KEY,  
DNAME VARCHAR(15) CONSTRAINT DEPT_DNAME_NN NOT NULL,  
MGRSSN CHAR(10),  
MGRSTARTDATE DATE);
```

EMPLOYEE

```
CREATE TABLE EMPLOYEE (  
SSN CHAR(10) CONSTRAINT EMP_SSN_PK PRIMARY KEY,  
NAME VARCHAR(18) CONSTRAINT EMP_NAME_NN NOT NULL,  
ADDRESS VARCHAR(18),  
SEX VARCHAR(3),  
SALARY REAL,  
SUPER_SSN CHAR(10),  
DNO NUMBER(3) CONSTRAINT EMP_DNO_FK REFERENCES DEPARTMENT (DNO));
```

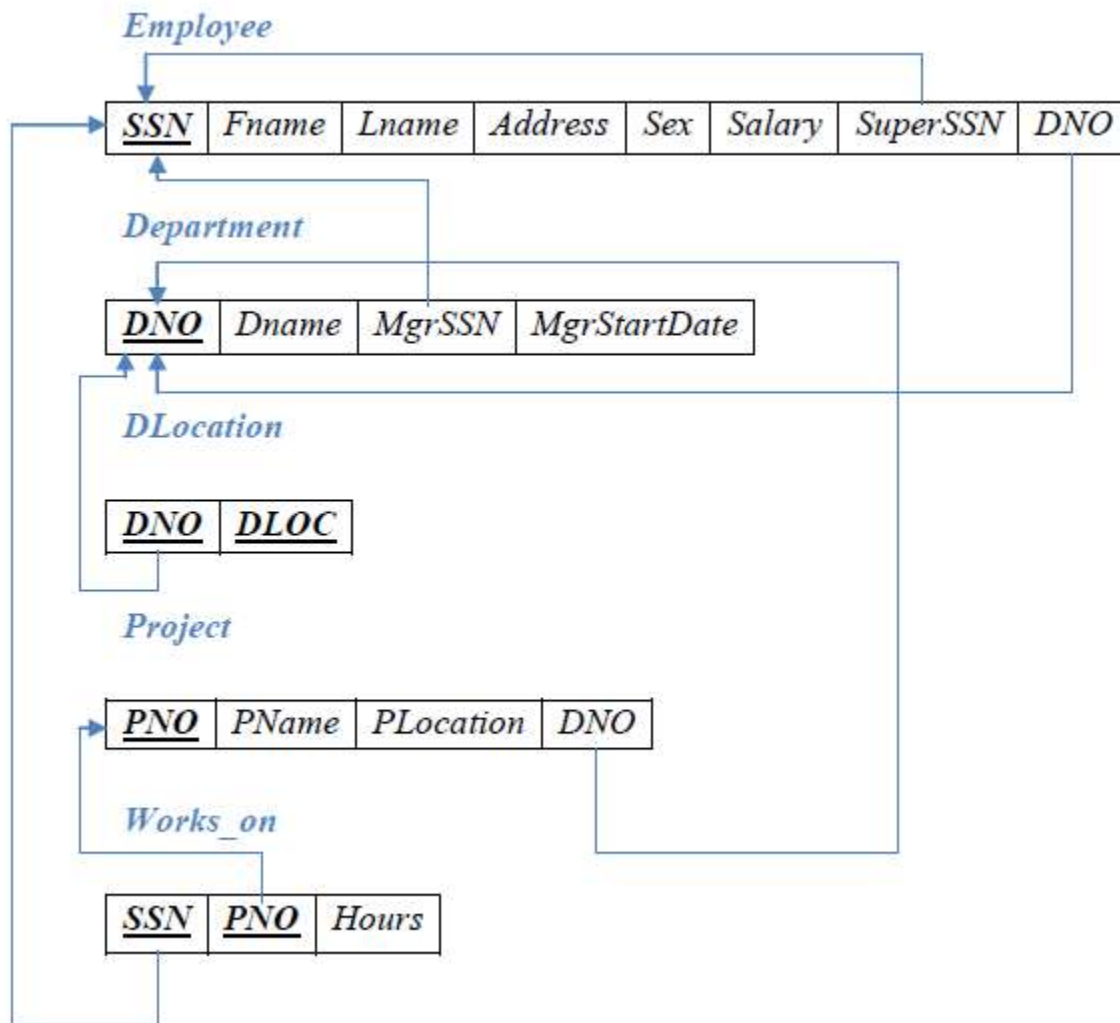
```
ALTER TABLE DEPARTMENT ADD CONSTRAINT DEPT_MGRSSN_FK FOREIGN  
KEY (MGRSSN) REFERENCES EMPLOYEE (SSN);
```

Table altered.

DLOCATION

```
CREATE TABLE DLOCATION (  
DLOC VARCHAR2 (20),  
DNO REFERENCES DEPARTMENT (DNO),  
PRIMARY KEY (DNO, DLOC));
```

PROJECT

```
CREATE TABLE PROJECT (  
PNO INTEGER PRIMARY KEY,  
PNAME VARCHAR2 (20),  
PLOCATION VARCHAR2 (20),  
DNO REFERENCES DEPARTMENT (DNO));
```

WORKS_ON

```
CREATE TABLE WORKS_ON (  
HOURS NUMBER (2),  
SSN REFERENCES EMPLOYEE (SSN),  
PNO REFERENCES PROJECT (PNO),  
PRIMARY KEY (SSN, PNO));
```

```

INSERT INTO DEPARTMENT VALUES (&DNO, '&DNAME', &MGRSSN, '&MGRSTARTDATE');

INSERT INTO EMPLOYEE
VALUES ('&SSN', '&NAME', '&ADDRESS', '&SEX', &SALARY, '&SUPERSSN', &DNO);

INSERT INTO DLOCATION VALUES (&DNO, '&DLOC');

INSERT INTO PROJECT VALUES (&PNO, '&PNAME', '&PLOCATION', &DNO);

INSERT INTO WORKS_ON VALUES ('&SSN', &PNO, &HOURS);

SELECT * FROM EMPLOYEE;

```

SSN	NAME	ADDRESS	SEX	SALARY	SUPERSSN	DNO
111111	RAJ	BENGALURU	M	700000		1
222222	RASHMI	MYSORE	F	400000	111111	2
333333	RAGAVI	TUMKUR	F	800000		3
444444	RAJESH	TUMKUR	M	650000	333333	3
555555	RAVEESH	BENGALURU	M	500000	333333	3
666666	SCOTT	ENGLAND	M	700000	444444	5
777777	NIGANTH	GUBBI	M	200000	222222	2
888888	RAMYA	GUBBI	F	400000	222222	3
999999	VIDYA	TUMKUR	F	650000	333333	3
100000	GEETHA	TUMKUR	F	800000		3

10 rows selected.

```

SELECT * FROM DEPARTMENT;

```

DNO	DNAME	MGRSSN	MGRSTARTD
1	RESEARCH	111111	10-AUG-12
2	ACCOUNTS	222222	10-AUG-10
3	AI	333333	15-APR-12
4	NETWORKS	111111	18-MAY-14
5	BIGDATA	666666	21-JAN-10

```

SELECT * FROM DLOCATION;

```

DNO	DLOC
1	MYSORE
1	TUMKUR
2	BENGALURU
3	GUBBI
4	DELHI
5	BENGALURU

6 rows selected.

```
SELECT * FROM PROJECT;
```

PNO	PNAME	PLOCATION	DNO
111	IOT	GUBBI	3
222	TEXTSPEECH	GUBBI	3
333	IPSECURITY	DELHI	4
444	TRAFICANAL	BENGALURU	5
555	CLOUDSEC	DELHI	1

```
SELECT * FROM WORKS_ON;
```

SSN	PNO	HOURS
666666	333	4
666666	111	2
111111	222	3
555555	222	2
333333	111	4
444444	111	6
222222	111	2

8 rows selected.

1. Make a list of all project numbers for projects that involve an employee whose last name is 'Scott', either as a worker or as a manager of the department that controls the project.

```
(SELECT DISTINCT PNO
  FROM PROJECT P, DEPARTMENT D, EMPLOYEE E
  WHERE P.DNO=D.DNO AND
        SSN=MGRSSN AND
        NAME='SCOTT')
UNION
(SELECT DISTINCT P.PNO
  FROM PROJECT P, WORKS_ON W, EMPLOYEE E
  WHERE P.PNO=W.PNO AND
        W.SSN=E.SSN AND
        NAME='SCOTT');
```

PNO
111
333
444

2. Show the resulting salaries if every employee working on the 'IoT' project is given a 10 percent raise.

```
SELECT FNAME, LNAME, 1.1*SALARY AS INCR_SAL
FROM EMPLOYEE E, WORKS_ON W, PROJECT P
WHERE E.SSN=W.SSN AND
      W.PNO=P.PNO AND
      P.PNAME=' IOT' ;
```

SSN	NAME	ADDRESS	SEX	SALARY	SUPERSSN	DNO
111111	RAJ	BENGALURU	M	700000		1
222222	RASHMI	MYSORE	F	440000	111111	2
333333	RAGAVI	TUMKUR	F	880000		3
444444	RAJESH	TUMKUR	M	715000	333333	3
555555	RAVEESH	BENGALURU	M	500000	333333	3
666666	SCOTT	ENGLAND	M	770000	444444	5
777777	NIGANTH	GUBBI	M	200000	222222	2
888888	RAMYA	GUBBI	F	400000	222222	3
999999	VIDYA	TUMKUR	F	650000	333333	3
100000	GEETHA	TUMKUR	F	800000		3

10 rows selected.

3. Find the sum of the salaries of all employees of the 'Accounts' department, as well as the maximum salary, the minimum salary, and the average salary in this department

```
SELECT SUM(SALARY), MAX(SALARY), MIN(SALARY), AVG(SALARY)
FROM EMPLOYEE E, DEPARTMENT D
WHERE DNAME='ACCOUNTS' AND
      D.DNO=E.DNO;
```

```
SUM(SALARY) MAX(SALARY) MIN(SALARY) AVG(SALARY)
-----
640000      440000      200000      320000
```

4. Retrieve the name of each employee who works on all the projects controlled by department number 5 (use NOT EXISTS operator).

```
SELECT NAME
FROM EMPLOYEE E
WHERE NOT EXISTS( (SELECT PNO
                  FROM PROJECT
                  WHERE DNO=5)
                MINUS
                ( SELECT PNO
                  FROM WORKS_ON W
                  WHERE E.SSN=W.SSN) )
```

NAME

SCOTT

5. For each department that has more than five employees, retrieve the department number and the number of its employees who are making more than Rs. 6,00,000.

```
SELECT DNO, COUNT(SSN)
FROM EMPLOYEE
WHERE SALARY > 600000 AND
      DNO IN (SELECT DNO
              FROM EMPLOYEE
              GROUP BY DNO
              HAVING COUNT(SSN) > 5)
GROUP BY DNO
```

```
      DNO COUNT(SSN)
-----
      3         4
```

DATE:

SIGNATURE

REFERENCES

1. Elmasri and Navathe: Fundamentals of Database Systems, 5th Edition, Addison-Wesley, 2007
2. Raghuram Ramakrishnan and Johannes Gehrke: Database Management Systems, 3rd Edition, McGraw-Hill, 2003.
3. Silberschatz, Korth and Sudharshan: Database System Concepts, 5th Edition, McGraw-Hill, 2006.
4. C.J. Date, A. Kannan, S. Swamynathan: An Introduction to Database Systems, 8th Edition, Pearson Education, 2006.

VIVA QUESTIONS

1. Define Data.
2. Define Information.
3. Define Database.
4. Define DBMS.
5. What do you mean by processed data?
6. What do you mean by data management?
7. Which are the actions that are performed on the database?
8. Mention the different types of DBMS.
9. Define Data model.
10. Mention the different types of Data models.
11. Why database approach is advantageous than the file system approach?
12. Who is called as the father of RDBMS?
13. What do you mean by redundant data?
14. What do you mean by Data duplication?
15. Mention the different relational algebra operations.
16. Mention the different User interfaces provided by the database system.
17. Mention the different languages provided by the database system
18. What is the difference between select operation in relational algebra and in SQL?
19. What is the difference between JOIN and Cartesian product?
20. Mention the different types of Join operations.
21. What is the difference between EQUIJOIN and NATURAL JOIN?
22. What is the difference between OUTER JOIN and JOIN.?
23. What is the difference between OUTER UNION and UNION?
24. What do you mean by Union Compatibility.?
25. What do you mean by Type Compatibility?
26. Mention the different types of relational constraints.
27. Mention the different types of structural constraints
28. What do you mean by cardinality?
29. What do you mean by cardinality ratio?
30. What do you mean by degree of a relation?
31. What do you mean by entity integrity constraint?
32. What do you mean by referential integrity constraint?
33. What do you mean by NULL constraint?
34. What do you mean by unique constraint?
35. What do you mean by Check constraint?
36. Define functional dependency.
37. Define normalization.
38. Define normal form
39. Mention the different types of normal forms
40. What is the difference between 3NF and BCNF?
41. What do you mean by JOIN dependencies?
42. What do you mean by Inclusion dependencies?
43. What do you mean by Template dependencies?
44. What do you mean by Multivalued dependencies?
45. Define Project Join Normal form.

46. Define Domain Key Normal form.
47. Mention the informal guidelines for database design.
48. Define super key.
49. Define primary key.
50. Define foreign key.
51. Define unique key.
52. Define prime attribute.
53. Define trivial functional dependency.
54. When a FD is said to be fully FD?
55. Mention the different Armstrong's inference rules.
56. Why Armstrong's inference rules are said to be sound and complete?
57. Define denormalisation.
58. Define Transaction.
59. Mention the ACID properties.
60. Define schedule.
61. Is DBMS usage always advisable or some times we may depend on file base systems? Comment on the statement by describing the situation where DBMS is not a better option & file base systems is better.
62. Describe 3-level architecture of DBMS with details of languages associated at different levels plus the level of data independence.
63. How logical architecture of DBMS differs from physical architecture?
64. Create an E R diagram and relational schema to hold information about the situation in many institutions affiliated to some University, many teachers of different disciplines are teaching to many students enrolled in many courses offered by the university to the students through the institutions. Use concept of keys, aggregation, generalisation, cardinality etc. in a proper way.
65. What is the utility of relational algebra & relational calculus? Name some software's based on these concepts?
66. Comment on the statement "Set theory has contributed a lot to RDBMS" support it with the help of suitable examples.
67. "Redundancy of data is many times beneficial" Justify the statement, also describe the situation when redundancy will mess up the current data base status, at that instance of time what actions you will prefer to take.
68. In Oracle we are having variety of versions Oracle 8, Oracle 9, etc, what does the associated number mean. Again we are having Oracle 8i, Oracle 9i etc, what does this "i" mean.
69. Describe the various file organization techniques? How a binary tree is different from B-tree and B+ tree? Under which situation we need to use B+ tree or B tree. Prove "Any relation which is in BCNF is in 3NF, but converse is not true"
70. Which functional dependencies are to be removed to achieve respective normal form? Discuss all the normal forms up to 4NF?
71. What is the mathematical basis of SQL? The SQL statement: select * from student will perform like projection or selection? Give details in support of your answer.